

Environmental Science

LABORATORY MANUAL

FOR

Senior Secondary Course

Course Coordinator

Neelam Gupta



NATIONAL INSTITUTE OF OPEN SCHOOLING
A-24/25, INSTITUTIONAL AREA, SECTOR-62, Noida-201309 (U.P.)

(Copies)

ADVISORY COMMITTEE

Dr. S.S. Jena
Chairman
NIOS

Dr. Kuldeep Agarwal
Director (Academic)
NIOS

Mrs. Gopa Biswas
Jt. Director (Academic)
NIOS

CURRICULUM DEVELOPMENT COMMITTEE

Chairperson

Prof. C.K. Varshney

Retd. Professor
School of Environmental Sciences
JNU, New Delhi

Members

Prof. T.R. Rao
Retd. Professor
School of Environmental Studies
University of Delhi

Dr. Yash P. Abrol
Deptt. of Environmental Botany
Hamdard University
Delhi

Dr. S.M. Nair
Programme Director
Centre of Environmental Education
B-73, Soami Nagar, New Delhi

Dr. B.S. Attri
Retd. Advisor (Environment)
Ministry of Environment & Forest
Govt. of India, New Delhi

Dr. Geeta Kaikar
Reader, School of Science
IGNOU, Maidan Garhi
New Delhi

Mr. Srikanta Panigrahi
Director Environment
(Room No. 317), Yojana Bhawan
Parliament Street, New Delhi

Ms. Neelam Gupta
National Institute of Open Schooling
A-24/25, Institutional Area, Sec- 62
NOIDA

COURSE EDITORS

Prof. C.K. Varshney
Retd. Professor
School of Environmental Sciences
JNU, New Delhi

LESSON WRITERS

Dr. Bharati Sarkar
Retd. Reader (Zoology)
Maitriyi College, Delhi

Dr. Aparna Konar
Retd. Reader (Botany)
Maitriyi College, Delhi

Mrs. Shivani Goswami
Retd. PGT & HOD (Biology)
Mother International,
Sri Aurobindo Marg, Delhi

Sh. Rajeev Vishnoi
RPVV, Surajmal Vihar, Delhi

GRAPHIC ARTIST

Mr. Mahesh Sharma
Graphic Artist
NIOS, NOIDA

A NOTE FROM THE DIRECTOR

Dear Learner,

Greetings from the Academic Department of National Institute of Open Schooling. It is a matter of pleasure for us that you have chosen the subject of Environmental Science for your Senior Secondary programme. This subject has a lot of scope for professional development and you may like to explore a career in this area.

It has been our endeavour to design the curriculum in such a way that it is relevant to every day situation in our life. The purpose of teaching Environmental Science is not only to acquaint you with theoretical knowledge but also to develop practical skills. This is an expected outcome of this endeavour. There is enough scope for developing experiments in different ways so as to bring out the creativity inherent in each one of you.

Experimental studies that are designed for you will help you to understand the various positive and negative forces working on our environment. Each one of us including you plays a vital role in influencing a change in our environment. You can become a promising conservationist of nature—a common wealth of the entire humanity.

Hope you will make the best use of this practical manual that can play a vital role in Nature's conservation.

Wishing you all the best



(Kuldeep Agarwal)
Director (Academic)

A WORD WITH YOU. . . .

Congratulations on selecting a subject for study with immense topical value! Environment is the storehouse of all resources that we need for our survival and well being. But its deterioration due to the impact of human activities is now a global concern.

It is vital to protect our environment for our future generations and also for ourselves for a clean and safe environment enables us to lead healthy and productive lives.

With these objectives in mind, the curriculum for practicals in Environmental Science has been devised while practical exercises will give you hands-on experience, this manual will help you carry out the exercises.

There are 17 exercises, which include 7 Field Studies, 4 laboratory exercises and 6 creative exercises. Out of these you are required to carry out any 3 field studies, 4 laboratory exercises and 2 creative exercises, In all you will do 9 exercises. All 17 have been outlined in the manual for your guidance. Follow them and keep in mind the precautions while you work them out.

Hope you enjoy doing these exercises. In case you need help, seek help from your teacher or write to us.

Good luck and wish you success now and future.



(Neelam Gupta)
Course Coordinator

CONTENTS

S. No.	Name of the Practical	Page No.
1.	Introduction	1
2.	Field Study	
	Exercise - 1	5
	Study of a simple ecosystem (Suggested habitats: pond, river, estuarine, grassland, forest and desert) and description of the biotic and abiotic components of the ecosystem.	
	Exercise - 2	8
	Study of effects of human interaction with natural environment.	
	Exercise - 3	11
	Survey of vegetation, birds, insects and other animals in an area.	
	Exercise - 4	15
	Choose five common species of Trees / plants from your NEIGHBORHOOD and list their common names. Describe each plant in terms of its height and leaves.	
	Exercise - 5	20
	Describe the environmental problem of your locality and suggest a remedy.	
	Exercise - 6	23
	Identifying the sources of pollution in water obtained from different sources.	
	Exercise - 7	25
	To segregate domestic waste into bio-degradable and non-biodegradable components.	
3.	Lab Exercise	
	Exercise - 8	28
	To study the quality of a sample of water collected or provided.	
	Exercise - 9	34
	To determine Texture of various soil samples.	

Exercise - 10 38

To estimate the amount dust (particulate matter) deposition on the leaves of roadside plants.

Exercise - 11 42

To Study the effect of light intensity on the growth of plants.

4. Creative Exercise

Exercise - 12 45

To set up an aquarium.

Exercise - 13 52

To study the biodiversity of birds and insects in your locality.

Exercise - 14 56

To prepare a list of plants and animals which are used for making meals at home on any one day and to comment on the habit and habitat of each.

Exercise - 15 59

To make a herbarium sheet.

Exercise - 16 62

To describe : a) climate of an urban area; b) yearly variation in suspended particulate matter in the same area.

Exercise - 17 66

To Make an audit of the electrical energy consumption by various household appliances.

Appendix I – Curriculum of practical



Notes

Introduction

Practicals are an integral part of understanding and learning a particular subject. For the course in Environmental Science, practicals include field studies, laboratory exercises (analysis), and creative activities. These exercises are not only relevant to get a better understanding of environment but also provide hands-on experience at devising methods for preventing environmental degradation.

OBJECTIVES

- Appreciate the interrelationship between living and non-living components of our environment;
- Understand the impact of human activities on the local environment;
- Understand biodiversity and interdependence of plants and animals and their relationship with the environment;
- Understand pollution and its harmful effect on the environment and devise strategies for reducing pollution;
- Realize the importance of energy and relevance of energy audit for the conservation of energy;
- Learn about assessing the quality of air, water and soil.

THE FORMAT OF THIS MANUAL

The exercises presented in this manual are in the form of self-instructional material. Each exercise in the manual has the following format.



Notes

1. **Aim** : It defines the scope of the exercise.
2. **Introduction** : It describes the purpose and relevance of the exercise.
3. **Objectives** : The objectives give you an idea of what is to be learnt from the exercise.
4. **What you should know** : It highlights the concepts and background knowledge pertaining to each specific exercise. You should familiarize yourself with the relevant concepts and information for doing the exercise successfully.
5. **Materials** : Is a list of various materials, apparatus etc. required to carry out the exercise.
6. **Method** : It includes the steps to perform the exercise in a sequential manner.
7. **Precautions** : The relevant precautions to be taken in carrying out the exercises are listed. Specific precautions if any, are listed alongwith the relevant step of the exercise.
8. **Observations/Results** : A detailed format of recording observations is provided. Draw diagrams, wherever necessary.
9. **Conclusions/Discussion/ Interpretation** : Justify the relationship between the aim of the exercise, the principle underlying it and the results obtained.

1. HOW TO USE THIS MANUAL

- a. Read the aim of the exercise carefully. Try to understand what is required to be done.
- b. Assemble all materials to carry out the exercise.
- c. Carefully read the methodology given in the procedure and the step by step instructions.

- d. Try noting down the observations then and there instead of doing it later. Draw the diagrams as you actually see them. Maintain a neat and completed record book. It carries 3 marks.
- e. Apart from the general precautions to be taken while working in a laboratory, also follow the precautions given either at the end or in between the instruction steps for each practical. Do not avoid these precautions if you want better results as they are very specific for the particular experiment.
- f. Do not forget to carry your manual with you when you go for the practical work.

*Notes*

Once again the steps involved in performing a practical are listed below in the chart to help you do the practicals.

Read instructions carefully	Follow each step	Make observations
		Note down all observations
		Transfer observations in Record Book
Write precautions, discussion and your comments.		

2. SAFETY IN THE LABORATORY (DO'S AND DON'TS)

- i. Be well aware of the exercise you are going to perform in the laboratory.
- ii. Use clean, instruments, glassware, and equipment. Replace them after completion of the exercise.
- iii. Handle microscope and other delicate instruments gently and properly. Be at least 5 inches away from the edge of the table to avoid knocking it off accidentally.



Notes

- iv. Do not throw any broken glassware in the sink. It should be thrown in the dustbin.
- v. Never eat in the laboratory to avoid infection.

3. MAINTENANCE OF RECORD BOOK

We hope you will follow the instructions listed in each exercise while performing it and record your observations in your notebook. You may use the following style for writing the exercise in your record book.

- Aim of the exercise.
- Materials required.
- Method or procedure followed.
- Observations made
- Record/tabulate your observations draw diagram wherever necessary.
- Conclusions / Discussion / Interpretation.
- Precautions taken during experimentation.

*Notes*

EXERCISE - 1

AIM : STUDY OF A SIMPLE ECOSYSTEM (SUGGESTED HABITATS: POND, RIVER, ESTUARINE, GRASSLAND, FOREST AND DESERT) AND DESCRIPTION OF THE BIOTIC AND ABIOTIC COMPONENTS OF THE ECOSYSTEM.

An ecosystem is a self sustaining and self regulating system in which living organisms interact with each other and with their environment. A pond is a good example of an aquatic ecosystem. The study of pond ecosystem is a very simple means to understand how various organisms are related to each other and their interdependence.

OBJECTIVES

After performing this exercise, you will able to:

- acquire the skill of making detailed observations of any eco-system and specially the pond ecosystem;
- identify and classify the biotic and abiotic components of the ecosystem;
- study the effects of abiotic (physical) components on the biotic(living) components;
- identify and list the various plants and animals that live in the pond.

MATERIAL REQUIRED

- | | |
|-------------------------------------|---------------------------|
| (i) Secchi disc | (vi) Microscope |
| (ii) pH paper | (vii) Slide |
| (iii) Universal indicator | (viii) Cover slips |
| (iv) Long thread | (ix) Long stick with hook |
| (v) Digital pH meter of pencil type | (x) Pencil and paper |



Notes



Fig. 1.1 Secchi disc



Fig. 1.2 Digital pH meter of Pencil type

METHOD

I To study physical components of a pond

- The physical or abiotic components includes temperature, light intensity, pH of water, dissolved gases (oxygen and carbon dioxide).
- To study pH value of water.
- Collect water from the pond at midday when the sun is bright and rate of photosynthesis of aquatic plants is at its maximum.
- Divide the sample into two parts. Put one part of the sample in a dark place in a closed container for 24 hours. From the other part, take 2 mL of water in a test tube. Add few drops of universal indicator. Match the colour developed in the test tube with the chart pasted on the indicator bottle and note its pH value.
- From the sample kept in a dark place for 24 hours, take 2 mL of water and find and record its pH value, compare the two observations.

II To study the biotic component of the pond

- Pick up the plants and animals present near the margin of the pond by hand (you may use hand gloves) and put them in the polythene bags. Bring them to the laboratory. Use microscope whenever necessary.
- Collect the submerged plants with the help of a long stick with hooked tip. Draw diagrams of all the organisms you collect from the pond.
- Collect the plankton (algae, protozoans etc.) by collecting water in wide mouthed bottles. Put one drop of water on a slide under microscope. Draw diagrams of as many kinds of organisms you observed under the microscope, as possible.
- Arrange them as phytoplankton and zooplankton.

OBSERVATIONS

- (i) Record the pH values of two water samples.
-

Record the various biotic components. Group them as producers and consumers as shown under:

A. Producers are green plants. They may be arranged as –

- (i) Phytoplankton : _____
(ii) Free floating : _____
(iii) Anchored / submerged : _____
(iv) Rooted floating : _____

B. Consumers are animals. They may be arranged as –

- (i) Primary consumers : Zooplanktons, molluscs and insects, _____
(ii) Secondary consumers : Small fish, insects and frog, _____

Record your observations and draw diagrams of plants and animals you have collected and identified. Seek help from relevant lessons in your despatch.

DISCUSSION

- Ponds serve as good examples of fresh water ecosystem. A pond exhibits a self-sustaining and self-regulating system. A pond is an aquatic ecosystem where both plants and animals live and interact with the environment, that is water to create a special physico-chemical environment which you will appreciate when you make a study of the biotic and abiotic components.
- A pond can be man-made or artificial and natural. A pond may be temporary, that is it may dry up at certain times of the year or may remain filled with water all the time.

PRECAUTIONS

1. For collecting the samples, do not enter the pond even if you happen to be a swimmer. Collect samples from the margins of the pond. Be careful of the slippery mud at the margin of the pond.
2. Take help of the teacher while collecting the plants and animals.
3. Observe the algae and other organisms under the microscope.

FOR THE TEACHER

- Please help learners identify and classify organisms into various categories mentioned under observations.



Notes



Notes

EXERCISE - 2

AIM : STUDY OF EFFECTS OF HUMAN INTERACTION WITH NATURAL ENVIRONMENT.

The continuing degradation of the environment due to human activities is of serious concern. We draw material for our survival from the environment. But overexploitation of environmental resources has not only caused alarming resource depletion but also has had an adverse effect on the environment per se. This exercise will help you become aware of the enormity of environmental problems created by human activities.

OBJECTIVES

After performing this exercise, you will be able to:

- become aware of environmental deterioration due to human activities;
- be able to think of strategies for reducing or reversing the adverse impacts.

MATERIAL REQUIRED

- | | |
|----------------------------------|----------------------------|
| (i) Microscope | (v) Net |
| (ii) Polythene Bag | (vi) Notebook |
| (iii) Long stick with hooked tip | (vii) Pen for making notes |
| (iv) Collecting bottles | |

METHODS

Different steps in carrying out a project:

- Identifying the theme.
- Choose any topic from the given list or any other but relevant to the issue of impact of human interaction with environment. You may discuss with friends and teacher and then select.



Notes

1. Planning and execution.
2. Set a time frame.
3. Collect data. Record it.
4. Arrange data in the relevant sequence.
5. Write project report. Include in the project report the following:
 - (i) **Introduction:** Introduce the topic and its relevance.
 - (ii) **Objectives:** Aims of the project.
 - (iii) **Material required:** Notebook, pen for making notes, microphone and tape recorder (optional), binocular (optional), polythene bags, collecting bottles, net.
 - (iv) **Methods:** Description of work area, communication with people, experiment if required, technique used if any, samples for collection, photograph if possible.

Suggested topics for the project. You need to choose one out of these

- Impact on a pond or river.
- Settlement habitation by the side of a drain.
- Effect on land use – deforestation
- Survey of deforested areas.
- Effect on water table (and compare with historical values from past records/ or through internet.)
- Survey of solid waste disposal site.

Finding out the extent of awareness regarding human impact on environment change.

OBSERVATIONS

- (i) The actual data collected may be presented in a tabulated form or narrative form or graphs. No interpretation is required.

ANALYSIS AND RESULTS

The findings are to be interpreted which shall includes reasons for degradation. Mention developmental activities responsible for the degradation.

DISCUSSION

- Your interpretation of your observations may be compared to similar studies available in newspapers or magazines or books.



Notes

- Give your independent opinion regarding extent of damage to environment and suggestions for reducing the damage and possibility of restoring the environment if any.

CONCLUSION

- You may suggest improvement and ‘do’s and dont’s for reducing and reversing adverse effects of human activities on their environment.
- Please remember that it is necessary to submit project in time.

PRECAUTIONS

1. Try to visit damaged sites during the day and in groups.
2. Take profuse notes which shall come handy when preparing the project report.

FOR THE TEACHER

- Help and guide the student in selecting the project and writing the project report.



Notes

EXERCISE - 3

AIM : SURVEY OF VEGETATION, BIRDS, INSECTS AND OTHER ANIMALS IN AN AREA.

We, the human beings share our living space with a wide variety of plants and animals. All of them contribute towards making our environment healthy and enjoyable. It is important to learn about them as they are our valuable companions.

OBJECTIVES

After performing this exercise, you will be able to:

- appreciate bio-diversity;
- identify some plants, birds, insects and animals.

MATERIAL REQUIRED

- | | |
|------------------|-----------------------------------|
| (i) Pencil / Pen | (iii) Nets for collecting insects |
| (ii) Notebook | (iv) Sheets for pressing plants |

METHOD

- Observe common plants, birds, insects and other animals as you walk around to go somewhere or your place of work. You may even specially visit a park / forest / hill / pond in your neighborhood for this purpose. Prepare a file and scrap book with photographs / pictures / drawings / pressed or collected specimens of atleast **3** plants (herbs, shrubs, trees), **3** birds, **3** insects and **3** other animals. You may record your observations in a format as suggest below or in any other way that you wish to observations.



Notes



(Herb)



(Shrubs)
3 Plants



(Rose Bush)



(Rabbit)



(Dog)
3 Animals



(Cat)



(Housefly)



(Mosquito)
3 Insects

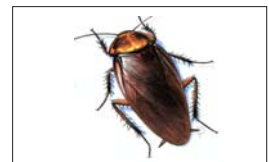

(Cockroach)



(Sunbird)



(Bulbul)
3 Birds



(Pigeon)

Fig.: 2.1 Pictures of some common birds, plants, insects and animals

OBSERVATION

Name:

(i) Local Name/English Name : _____

(ii) Scientific Name : _____

Time and Date of Observation : _____

Place of Observation : _____

Colour : _____

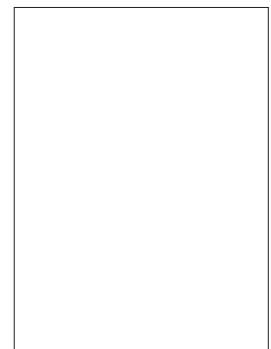

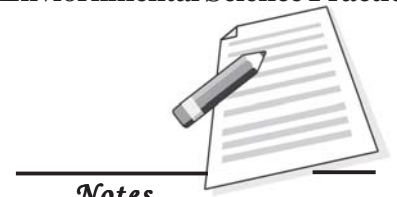

Special Feature/features: _____

1. _____ 2. _____
3. _____ 4. _____

Difference in male and female external structure and behavior: _____

In case of plants, apart from names of place, time and date of observation mention whether herb, shrub or tree or climber. For flowering plants you may even record the season of bloom and formation of fruits. Also record if the plant is an annual, biennial or perennial.

Any Other : _____

Pictures may be added :

- Vegetation** – A crop plant, a common herb, rose bush, money plant (or any climber), any tree.
- Birds** – Sparrow, parakeet, pigeon or dove, bulbul, sunbird.
- Insects** – Cockroach, housefly, mosquito, grasshopper, butterfly/ moth.
- Animals** – Cow, dog, cat, rabbit etc.

DISCUSSION

- Pictures of some common plants, animals, birds, and insects are given here for you to recognize them in nature.
- Mention where you observed these plants and animals and what was weather like on those days.
- You may include the utilization (useful) aspects of plant/animal listed by you if any.
- Behavior / nesting etc. may be studied and reported in case of birds.
- If your list of insects includes those of economic importance, make specific mention.

PRECAUTIONS

1. Do not disturb the birds so that they do not fly away and you can observe them well.

Environmental Science Practical



Notes

2. You may wear gloves if you wish to handle the plant or insect for close observation.

FOR THE TEACHER

- If a learner views an uncommon plant, insect or bird, help in identification.
- Help in appreciating biodiversity.



Notes

EXERCISE - 4

AIM : CHOOSE FIVE COMMON SPECIES OF TREES / PLANTS FROM YOUR NEIGHBORHOOD AND LIST THEIR COMMON NAMES. DESCRIBE EACH PLANT IN TERMS OF ITS HEIGHT AND LEAVES.

Plants constitute one of the most obvious components of our environment. Different types of plants are seen in our surrounding such as trees- large plants with stout trunks that stand freely, shrubs-bushy plants of medium height with branching close to the base and herbs- small plants with soft stems, usually found in a specific season. Even in a highly built up area one can find tiny plants in the form of mosses, grass and other small weeds. Ornamental and other potted plants can even be found indoors. Study of these plants/trees helps us in understanding the biodiversity in plant kingdom and in appreciating its significance.

OBJECTIVES

After performing this exercise, you will be able to:

- enlist various plants available in the area;
- point out the important features of the plants of the area;
- identify each plant on the bases of its height, the shape of stem and the shape of leaves;
- appreciate plant biodiversity.

WHAT YOU SHOULD KNOW

1. The distinction between the herbs, the shrubs and the trees.
2. The techniques of measuring the height of the trees.
3. The common names of the most common trees of the area.
4. The tracing technique: Put a leaf under a white sheet of paper or a sheet in your notebook. Hold it in place as shown in fig. 4.1

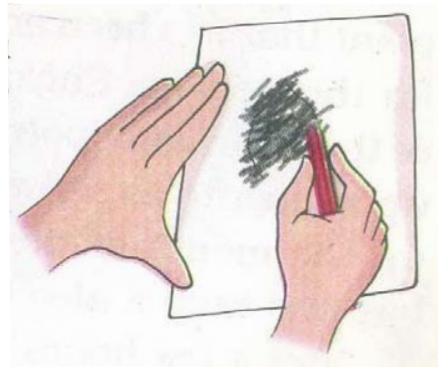
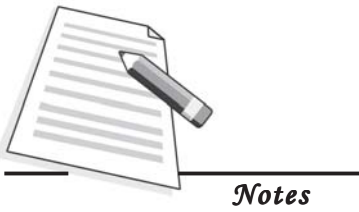

Fig. 4.1 Taking an impression of a leaf

Hold your pencil tip sideways and rub it on the portion of the paper having the leaf below it. (Remember to take soft pencil for this purpose)

These lines on the leaves are called veins. Observe the venation. It may be parallel or reticulate (optional).

MATERIAL REQUIRED

- | | |
|--------------|--------------------|
| (i) Copy | (iv) Clinometer |
| (ii) Pencil | (v) Tracing paper. |
| (iii) Rubber | |

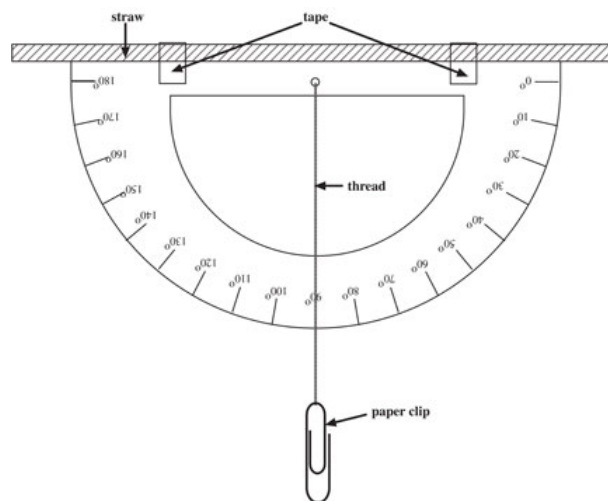

Fig. 4.2 Clinometer graph

HOW TO PROCEED

- (i) Select an area suitable for your field work. It may be your school campus or your locality or any other place inhabited by a good number of plants.



Notes

- (ii) Select any one plant. Write its common name.
- (iii) Observe the parts of the plant carefully.
- (iv) Take a leaf print and a print of its bark.
- (v) Measure the height of the plant. For measuring the height of a tall tree you can use any one of the following methods.

Method I

- (i) Measure angle of elevation (θ) of the top of the tree with the help of a clinometer.
- (ii) Measure the baseline distance (d) of the tree (i.e. the distance of the tree from the point of observation of angle of elevation of the top of the tree).
- (iii) Calculate the height of the tree using the formula:

Height of the tree = $d \tan \theta$

For example, suppose you have measured the baseline distance of 60 meters and the angle of elevation of the top of the tree is 34° . Then,

$$\begin{aligned} \text{Height of the tree} &= 60 \tan 34^\circ \\ &= 60 \times 0.67 \\ &= 40.2 \text{ m} \end{aligned}$$

- (iv) Select four more plant species and note down the observations in the similar manner.

Method II

- (i) In this method you do not need a clinometer. But you need help of a friend or any other person who is of the same height as yours.
- (ii) Ask him to stand very close to the base of the tree.
- (iii) You should stand at sufficiently large distance from the tree.
- (iv) Hold a scale/ ruler vertically in such a manner that the zero of the scale/ruler falls in the line joining your eye and foot of your friend.
- (v) Note the ruler marking falling in the line joining the head of your friend and your eye.
- (vi) Note the ruler marking falling in the line joining the top of the tree and your eye.
- (vii) Now, you can calculate the height of the tree using the following formula:

$$\text{Tree height} = \frac{\text{Friend's height} \times \text{ruler marking for the tree} - \text{top}}{\text{Ruler marking for the friend's height} - \text{top}}$$



Notes

(viii) Select four more plant species and note down the observations in the similar manner.

OBSERVATIONS

(i) Observe the fully grown leaves and note their shapes, sizes, colours and margins.

(ii) Prepare a leaf-print and the leaf outline.

(iii) Describe the tree-trunk for its colour, thickness and surface texture.

(iv) Take a print of its bark.

(v) Is there any flower/fruit on the tree?

(vi) Is there any thorn or crucial root visible on the tree?

(vii) If the tree is in your home, you may find out how many years ago it was planted.

(viii) Additional information may also be recorded. For example -

- Is there any insect or other organism on the tree?

- Is there any bird-nest on the tree?

- Draw a picture of the tree.

(ix) Record the above information on separate sheets for each plant/tree.

**DISCUSSION**

- Mention perennial nature of trees.
- Comment on the variety.
- Comment on evergreen trees and those where there is leaf fall in a certain season.
- Mention usefulness of trees.

SPECIAL NOTE

- Observe the trees when you have enough time so that you may enjoy this activity.
- You may carry out this exercise with your friends. It will be enjoyable.

FOR THE TEACHER

- May help the learner in measuring the height of the plant either with the clinometer or otherwise.



Notes

EXERCISE - 5

AIM : DESCRIBE THE ENVIRONMENTAL PROBLEM OF YOUR LOCALITY AND SUGGEST A REMEDY.

Environmental problems differ from one area to another. Problems of pollution may be in the form of air pollution, water pollution or noise pollution. Garbage accumulation, soil erosion, loss of biodiversity are some other environmental problems that have reached an enormous proportion and need to be looked into find solutions.

OBJECTIVES

After performing this exercise, you will be able to:

- identify specific environmental problems associated with a particular locality;
- locate the cause of the environmental problem of a locality as an environmentalist;
- suggest remedies which may be simple and less expensive;
- describe the harmful effects of the existing environmental problems.

WHAT YOU SHOULD KNOW

1. You should be able to identify the major environmental problem of your locality. Some environmental problems are mentioned below. One of them may be a problem of your locality or it may be one not mentioned here.

a. Noise and air pollution

- In case you live in a crowded urban area, you are certain to face air pollution and noise pollution.

b. Problems of drinking water and sanitation

- If you live in rural areas, you may face the crisis of clean drinking water and problems of smoke from burning coal as also sanitary problems.
- In semi-urban highly populated slum areas, one might face the scarcity of

clean drinking water and open drains with sewage disposal problem and other sanitary problems.

c. Soil erosion and landslide

- In hilly areas one faces the problem of drinking water as well as cutting of trees leading to soil erosion, making the mountains exposed and vulnerable to landslides.

d. Garbage accumulation

- Can create problem in the cities, which can be dealt with by converting the garbage into manure.

*Notes***MATERIAL REQUIRED**

- (i) Your requirement will depend upon the type of problem you are handling.
- (ii) Notebook and pen will be required.

METHOD

- Air pollution by dust and fuel smoke can be dealt with by contacting the authorities who are authorized to take steps to control it. Like for example, if the soil is dug by water, electricity, telephone or sewage departments creating dust problems, they can be asked to repair the dug up roads.
- Noise pollution can be controlled by contacting the appropriate authorities.
- Similarly industrial pollution can be handled by contacting the authorities.
- Clean drinking water must be made available to people, you may form an association and inform the authorities or bring it to their notice.
- Cutting of trees in the hills must be prevented and you must play your role in educating the people for the same. Trees may be used for various purposes but then lot of trees must be planted on a commercial scale to hold the soil in place on the hills.
- Accumulation of garbage in your locality might create health problems. You may make a group and help to separate out the biodegradable garbage and compost it to make manure which can be used in gardens and parks.

OBSERVATIONS

- (i) Make a detailed list of the environmental problems of your locality.

- (ii) Find the main or primary environmental problem and its cause.

Environmental Science Practical

*Notes*

- (iii) Find out the names of people who can be contacted to rectify the problem.
-
- (iv) Form a welfare association or in case there is already one, force them to take steps to check the environmental problem.
-
- (v) Educate your neighbour in your locality to collect the biodegradable garbage and convert it by vermicompost method into compost or manure. The manure can be sold to individuals for their kitchen gardens or may be used in the community parks and gardens.
-

DISCUSSION

- Discuss with respect to the source/ cause of the problem, its harmful impact and how it can be tackled to prevent further degradation.

PRECAUTIONS

1. Take help of your teacher in locating or identifying the real environmental problem.
2. You should know your limitation and not annoy anyone in order to solve your environmental problem.

FOR THE TEACHER

- Teacher may explain to the learner the environmental problem and its effects on the health of people in the neighbourhood.
- Teacher should suggest to the learner, how he/she should go about to solve the problem, and who all can he/she contact for such problem.

*Notes*

EXERCISE - 6

AIM : IDENTIFYING THE SOURCES OF POLLUTION IN WATER OBTAINED FROM DIFFERENT SOURCES.

Water pollution is defined as the presence of some foreign, organic, inorganic or biological substances in the water that degrade the quality of water and make water unfit for various uses. Visit different water bodies in your village/locality, describe their uses and sources of water pollution.

OBJECTIVES

After performing this exercise, you will be able to:

- know about various sources of fresh water;
- become aware of about various sources which pollute water bodies;
- suggest methods that can be employed to check such pollution;
- spread the message in the locality to check pollution of the water body.

WHAT YOU SHOULD KNOW

1. Most of the solid and liquid waste, today, are disposed off into rivers, ponds and lakes.
2. Pollutants found in water are –
 - (i) Domestic sewage containing human waste from kitchens and toilets.
 - (ii) Industrial discharges often contain alkalis or acids and organics with toxic heavy metals.
 - (iii) Organic pollutants from dairy farms, slaughter houses, breweries, tanneries and paper mills.

MATERIAL REQUIRED

(i) Notebook

(ii) Pen/pencil



Notes

METHOD

- (i) You may visit any river or lake or pond in your locality and record the main causes of its pollution.
- (ii) Check whether it is a flowing river with adequate water or a river with very little water. (Loading of garbage and sewage into rivers pollute it and gradually the river starts drying.)
- (iii) Check and record whether people use the river or lake water for bathing, washing clothes and utensils and bathing animals.
- (iv) Does it have an industry nearby? Does the river receive any industrial effluents? You may take the help of elder or friends in finding those details.

OBSERVATIONS

- (i) Check the colour of water. For example turbid water may be caused by domestic waste or detergents. Red, lifeless water may have sewage and industrial waste.

- (ii) Check the smell of water. Does it smell of toxic matter or does it smell of sewage?

- (iii) From the colour, smell and turbidity, mention and identify the cause of pollution.

- (iv) Record your observations.

DISCUSSION

- Mention various water pollutants and the problems and harmful effects of having a polluted water in the locality.

PRECAUTIONS

1. Never taste or smell any polluted water frequently or too closely to avoid any harm to yourself.
2. You should visit such places in a group with a trained person.
3. Try to wear gloves wherever handling polluted water.

FOR THE TEACHER

- Teacher may help the learner to locate water bodies which are highly polluted.
- Teacher may help the learner to compile the data collected by the learner.



Notes

EXERCISE - 7

AIM : TO SEGREGATE DOMESTIC WASTE INTO BIO-DEGRADABLE AND NON-BIODEGRADABLE COMPONENTS.

In modern times, a large number of resources are used at home and their use generates an equally large quantity of wastes. You must have noticed that in day to day living what a large amount of solid waste gets generated. It includes vegetable and fruit peels, empty cartons and bottles, broken pieces of metal and glass, pieces of paper, dust from outside etc. It would be interesting to examine the amount and kind of solid waste generated everyday at home.

OBJECTIVES

After performing this exercise, you will be able to:

- distinguish between non-biodegradable and bio-degradable waste;
- get an idea of the volume and kind of solid waste generated at home;
- make a comparison of volumes of various kinds of generated waste;
- work out a strategy for reducing waste generation and disposing waste properly.

MATERIAL REQUIRED

- (i) Bags (plastic or paper) for collecting of waste
- (ii) Old newspaper
- (iii) Weighting scale
- (iv) Gloves
- (v) Rod for segregating waste.



Notes

METHOD

- Everyday, for seven days collect garbage generated in your house / home in a bag.
- Wear gloves and each day segregate the biodegradable from non-biodegradable waste with the help of the rod and put them in different bags. You may segregate them during collection of the waste.
- Further segregate different waste items of both kinds of waste.
- Weigh them separately and list and record the items of bio-degradable waste and their sources.

OBSERVATIONS

After a week, collate the data for a week and find the average and record as shown below:-

S. No.	Waste item	Source	Total weight	Average wt/day	Nature of waste
1.	Paper	Box of sweets, Gift wrappers, Burnt crackers etc			Biodegradable
2.	Clothes	Cloth bags, Torn Duster etc			Biodegradable
3.					
4.					

NOTE

- You may try this exercise during a festival and get an idea of how much more solid waste gets generated in homes during festivals.

DISCUSSION

- Why are you classifying listed items in biodegradable or non-biodegradable?

- Express your views regarding the volume of garbage generated.

- Express the ways by which garbage may be reduced or disposed?

- Write a paragraph on how increase in consumerism is responsible for increase in waste generation.
-



Notes

CONCLUSION

- More things you buy, more waste you generate.

FOR THE TEACHER

- Help learners in distinguishing non-biodegradable from biodegradable waste.

*Notes*

EXERCISE - 8

AIM : TO STUDY THE QUALITY OF A SAMPLE OF WATER COLLECTED OR PROVIDED.

Water is the elixir of life. No organism can live without water. For aquatic organisms, it is their natural habitat. Hence water quality is very important. In this exercise we shall study the turbidity, clarity and pH of a sample of water and detect the presence of chlorides, carbonates and bicarbonates in it. We shall also study the colour, smell and pollutants in a sample of dirty water.

OBJECTIVES

After performing the exercise, you will be able to:

- comment on the quality of the given sample of water;
- study of quality of water includes physical properties such as turbidity, temperature, presence of pollutants, and presence of oil or grease, and
- study the quality of water includes chemical properties like pH, alkalinity, hardness, salinity, dissolved oxygen content and amount of carbon-di-oxide present.

MATERIAL REQUIRED

- | | |
|---|-------------------|
| (i) Two beakers / containers, | (v) pH paper |
| (ii) Six test tubes, | (vi) Microscope |
| (iii) Gloves for collection of drain water, | (vii) Slides |
| (iv) Thermometer, | (viii) Coverslips |

METHOD

A. Collection of water sample

- Water sample may be collected in any container from tap, hand pump,

pond, well, canal, river, estuary, sea or any other source of water available in your neighborhood.

- Collection of polluted water may be from a drain or eutrophied pond.



Notes

B. Testing water quality

1. To observe turbidity or clarity of water sample

- Turbidity may be due to abundant plankton (floating living organisms) whose presence may be detected by taking a drop from the sample of water and observing under a cleaned microscope.
- When fine particles of silt are suspended in water, it looks turbid. This can also be checked by placing a drop of water sample under hand lens or microscope.
- Record your observations.
- Turbidity interferes with penetration of light and affects biological productivity.
- The clarity of drain water may be compared with clean water taken in two different test tubes, by simply observing the clarity and recording it.

2. To record temperature of water

- Temperature of water varies with seasons and at different times during the day, as also in different places (tropical and temperate regions).
- Temperature may be recorded with a standard mercury thermometer, at the site of collection of water sample. Take atleast three readings each time and record. (Dial thermometers / electronic temperature recording device / maximum – minimum thermometer or thermographs may be used if available).



Fig. 8.1 Dial thermameter

Also record the temperature of the drain water.

*Notes***3. To record the colour and smell of water.**

- Observe the colour and smell of both water samples and record your observations.

4. To check the pH of the sample of water.**Apparatus and reagents required**

pH paper / pH meter / universal indicator, sample of water.

Principle

Natural waters may be acidic or alkaline or neutral. Water from majority of natural bodies is slightly alkaline. Acidic water of pH less than 6 is much less productive than alkaline water. Alkalinity may be due to carbonates, bicarbonates and hydroxide of calcium.

Procedure

- Take some water from the collected/given sample of water in a beaker or test tube.
- Check and record the pH of the water sample by means of pH paper or pH meter and record.
- Also check the pH of polluted water.

5. To test presence of chlorides in the given sample of water**Apparatus and reagents required**

- Test tubes, silver nitrate.

Principle

Chloride with silver nitrate forms an insoluble precipitate of silver chloride.

- $\text{NaCl} + \text{AgNO}_3 \rightarrow \text{AgCl} + \text{NaNO}_3$
(White ppt)

Procedure

- Take 10ml of the given sample of water in a test tube.
- Add two-three drops of silver nitrate.
- Titrate with 0.01N .
- A white precipitate of silver chloride will indicate the presence of chloride in the water sample.

6. To test the presence of carbonates and bicarbonates in the sample of water.



Notes

Apparatus and reagents required

Test tubes, calcium chloride, ammonium hydroxide

Principle

When carbonates and bicarbonates are present together in a water sample excess solution of CaCl_2 is added to precipitate the carbonate. It is then filtered and the filtrate is used for testing the presence of bicarbonates.

Procedure

1. Water sample is taken in a test tube and excess of calcium chloride (CaCl_2) is added. White precipitate of CaCO_3 forms if sodium carbonate or potassium carbonate is present.



The precipitate is filtered.

2. To the filtrate NH_4OH is added to make it alkaline. White precipitate indicates the presence of bicarbonate.



7. To find out the presence of dissolved nutrients such as phosphates and nitrates in a sample of water.

Requirement

Water from eutrophied / polluted pond, test tubes, test tube holder, reagents as mentioned with each test, NH_4OH , $(\text{NH}_4)_3\text{PO}_4$, H_2SO_4 , FeSO_4 solution

Principle

Phosphates and nitrates of concentration 0.2 to 0.4 ppm and 0.06 to 0.1 ppm respectively may be found in water. Eutrophication may be due to field run off carrying fertilizers containing nitrate and phosphate. Their presence in water can be tested by standard salt analysis tests.

Procedure

Test for phosphate (PO_4)

- We do molybdate test for the presence of phosphate in the given sample.
- To the sample, add few drops of aqueous ammonium molybdate.
- Yellow precipitates of ammonium phosphate confirms the presence of phosphate.



Notes

Test for nitrate (NO₃)

- We do brown ring test for the presence of nitrate in the given water sample.
- Add to sample solution 10% FeSO₄ solution.
- Trickle conc. H₂SO₄ from side of test tube.
- Brown ring appears confirms presence of nitrate in water sample.

OBSERVATIONS

	Experiment	Observation	Results	Influence
Colour				
Smell				
Clarity				
Temperature				
pH				
Presence of salts carbonates				
Bicarbonates				
Phosphates				
Nitrates				
Chlorides				

CONCLUSIONS

- AgNO₃ forms white precipitate and hence the water sample contains chlorides.

- NH_4OH forms white precipitate and hence the water sample contains bicarbonates.
- Phosphates give the Molybdate test.
- Nitrates give the ring test.



Notes

PRECAUTIONS

1. All the glassware should be clean.
2. Freshly made reagents should be used.
3. Care should be taken while using the reagents.
4. Care should be taken while detecting the colour, pH, temperature and clarity of drain water.

FOR THE TEACHER

- Please supervise the laboratory tests performed by learners.



Notes

EXERCISE - 9

AIM : TO DETERMINE TEXTURE OF VARIOUS SOIL SAMPLES.

Soil texture is determined by the relative proportion of mineral particles of different sizes present in the soil. On the basis of the proportion of different sized particles, soil is classified into different textural groups.

Soil is composed of particles of different size. Accordingly the soil particles have been categorized.

OBJECTIVES

After performing this exercise, you will be able to:

- know that soil is not simple matter but is made up of mineral particles of different sizes and organic matter;
- know the size of the soil particle determines, the water retention ability of the soil.

WHAT YOU SHOULD KNOW

1. Soil is a mixture of mineral particles of different sizes and organic matter.
2. The varying percentage of different particles in the soil are responsible for the difference in soil texture of different soils.
3. According to the textural characteristics and relative proportion of different sized mineral particles, the soil may be named as follows:

Soil type	Relative proportion of different sized mineral particles
Sandy Soil	85% sand + 15% clay or silt or both
Loamy Sand	70% sand + 30% clay or silt or both
Loam Soil	50% sand + 50% clay or silt or both
Silt	90% silt + 10% sand



Notes

MATERIAL REQUIRED

(i) Paper bags for collecting soil samples	(v) Glass rod
(ii) Newspaper	(vi) Hand lens
(iii) Mortar and Pestle	(vii) Water
(iv) Measuring cylinder	(viii) Sives of different pore size.

METHOD

This exercise involves the following steps:

- Soil preparation.
- Finding the texture of soil.
- Determining size of particles in the soil sample.
- Recording observations.

(i) Soil preparation

- Take a paper bag and collect about half-a-kilogram of soil. Bring this to the laboratory and spread it for drying on a newspaper placed on a table.
- Cover it with a paper to avoid collection of dust from outside.
- When the soil sample is dry, pound it using a mortar and pestle so that the clumped particles break and the sample is more or less uniform.
- Store the sample in a container with lid to find the texture of soil.

(ii) To find the texture of soil

This can be done with the help of “Finger test”.

- Collect soil samples from three different localities in paper bags.
- Label the bags to indicate the locality and the date of collection.
- Repeat the above procedure with the different soil samples.
- Observe if it rolls into flexible rolled ribbons then it is wet clay, if rolled, if ribbons break easily. It can be clay loam.
- Stilt loam and sand soils can not be rolled in this manner.
- Calculate the percentage of particles of various sizes in the soil.
- From your calculations, identify the soil type by comparing with the table given in the beginning of the exercises.



Notes

(iii) To determine size of particles in the soil sample

- To determine size of soil particles in the soil sample, procure sieves with different pore size. (2mm, 0.2mm, 0.02mm and 0.0002mm).
- Check with the teacher that sieve has pores of uniform size.
- Take a measure amount of dry soil (say 100g) and place it in the sieve of smallest pore size.
- Shake gently. Particles of smallest size move out of the sieve on a paper.
- Store it.
- Repeat the above procedure with the different soil samples.
- Calculate the percentage of particles of various sizes in the soil
- From your calculations, identify the soil type by comparing with the table given in the beginning of the exercise at ‘what you should know’.

OBSERVATIONS

- (i) Comment on the texture of soil samples.
- (ii) Repeat the percentage of particles of various sizes in soil samples as shown below:-

S.No.	Soil sample	% Sand	% Silt	% Clay
1.	a. Soil from a crop land. b. Soil from the road side. c. Soil from river or any other source.			
2.				
3.				

DISCUSSION

- Soil could be categorized into textural groups depending on proportion of particles of different size.

PRECAUTIONS

1. Collect soil and seal the packets so that no dust or other soil gets mixed with it. Use gloves for collection.
2. As certain that sieves are of uniform pore size.
3. In finger test add enough water to make a light dough so that you can make ribbon of the dough.

4. In sieve method do not mix up the soil samples. Handle them carefully and individually.
5. Collect the different fractions of a sample from the sieve plates very carefully without dropping a grain of soil on the floor or table.



Notes

FOR THE TEACHER

- Help learners to check the sieves so that only these with uniform pore size are used.
- Identify the different layers formed by the soil in water.

*Notes*

EXERCISE - 10

AIM : TO ESTIMATE THE AMOUNT DUST (PARTICULATE MATTER) DEPOSITION ON THE LEAVES OF ROADSIDE PLANTS

Air pollution is a growing problem of all big cities today. Particulate and gaseous pollutants are the major contributors to air pollution which causes serious ailments, of which lung diseases happen to be more common. The particulate matter settles on various surfaces including plants and their leaves. Have you not seen roadside plants with significant deposition of these particulate matter on their leaves? Such deposition causes change in their colour and reduction in their photosynthetic efficiency.

Dust (fine dry particles of earth and other matter) and soot (black powdery substance when coal, wood etc. are burnt) collected from the leaf surface give us some idea of the extent of pollution in particular area. Dust estimation will provide an idea about the extent to which the plants help in keeping the air clean by removing the (atmospheric) dust.

OBJECTIVES

After performing this exercise, you will be able to:

- compare the level of dust (particulate matter) deposited on the leaves of road side plant and the plants away from the road side in a locality free from pollution (near your house/ park/home);
- get an idea of the extent of air pollution in your locality;
- appreciate the role of plants in removing the dust pollutants and keeping the air clean.

WHAT YOU SHOULD KNOW

Air pollutants include harmful gases (CO_2 , SO_2 , N_2O , CO) and particulate matter (soot, dust, pollen, fly ash, fine fibers, cement, some salts). Particulate matter settling on plant leaves can be used as an index to measure air pollution in an area/

locality. Try to complete this experiment on any one day during the dry season preferably between mid October to mid December. Level of pollution also varies at different heights and at different times of the day.



Notes

MATERIALS REQUIRED

- (i) Any two broad leaved plants of the same species and of the same height found growing one at the roadside and the other in an area free from pollution;
- (ii) Glossy paper / butter paper;
- (iii) Any light weight translucent paper;
- (iv) Fine paint brush;
- (v) A chemical balance;
- (vi) Graph paper;
- (vii) Pencil.

METHOD

- Select a plant of a certain height at a roadside/construction site (plant A) and another plant of the same species and of the same height growing preferably in a garden/park or at home (plant B).
- The first plant is your experimental one and the second one is the control/standard for comparison.
- Since the leaves vary in their size, select 10-15 leaves of the same size from each plant.
- To measure the amount of dust settled on the leaves, first weigh two pieces of butter paper measuring 6cm sq each. Let these foils be L_1 and L_2 and their weights x_1 and x_2 , collect the dust from all the 10-15 selected leaves say from the plant A with a fine brush on the foil L_1 . Similarly, collect the dust from plant B on the foil L_2 . Weigh the foils separately once more. Now you have the weight of the dust from 10-15 leaves of the experimental plant A. Let this weight be y_1 and also the weight of the dust from 10-15 leaves of the control plant B. (y_2)
- With the help of graph paper measure the areas of each of these leaves. To find the area, hold the leaf against the graph paper and mark its outline with a pencil. Now count the big and small squares to calculate the area of the leaf. Find the average area.



Notes

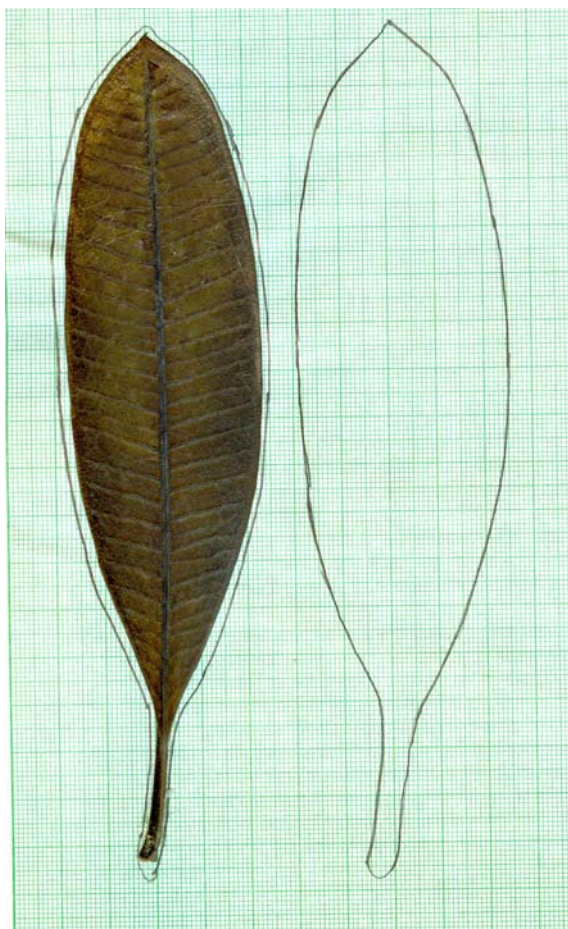

Fig.: 10.1 Diagram to show a leaf kept on a graph paper to measure its surface area.

OBSERVATIONS

Tabulate your observations as given below and compare and correlate the amount of dust collected with the leaf surface area and also compare the amount of dust collected from the two different sets of pots (plants).

Plants	Average area of 10 -15 leaves	Wt. of the butter paper/foil	Wt. of the dust and the butter paper/foil	Amount of dust collected on 10 -15 leaves (Y-X)	Amount of dust collected on 1 leaf
A		x_1 mg	y_1 mg		
B		x_2 mg	y_2 mg		

Compare the particulate matter collected from the two different sites. Record your result and conclusion.

CONCLUSION

- Concentration of pollutants is variable in different localities.
- More particulate matter is present at site _____. (Name the place).

NOTE

- If the weight of the particulate matter collected is too little you can take your observation using more leaves. But try to keep the number and size of leaves used from the two plants almost the same.

PRECAUTIONS

1. Perform the experiment on a non breezy and dry day.
2. Select the plants approximately of the same height as pollutants vary at different heights.

CHECK YOUR UNDERSTANDING

1. Which particulate pollutant is released from the automobile exhaust?

2. How are plants affected by the deposition of particulate matter on their leaves?

3. How are humans affected by these pollutants?

4. Name the particulate matter added to the air by plants.

5. Why do you choose roadside plants for your study?

6. Name some sources/processes which increase particulate matter in the air.

FOR THE TEACHER

- Please supervise the experimentation by the learner and also recording of the observations.

*Notes*



Notes

EXERCISE - 11

AIM : TO STUDY THE EFFECT OF LIGHT INTENSITY ON THE GROWTH OF PLANTS.

Light is a very important environmental factor which controls the growth and development of plants. Plants that grow in bright sunlight and those that grow in the dark look weak and unhealthy.

Light influences plant growth and development in different ways, depending on its intensity, duration and spectral quality. These factors are interrelated. In the present experiment we will demonstrate the importance of light intensity for the normal growth and development of a plant.

OBJECTIVES

After performing this exercise, you will be able to:

- To be able to understand the influence of light intensity on growth and development of plants.

MATERIAL REQUIRED

- (i) Three flower pots (15 cm diameter) or any other container of suitable size,
- (ii) Garden soil,
- (iii) Healthy seeds of moong / wheat / barley / pea.

METHOD

- Fill the three pots with garden soil and add enough water to make the soil just moist. Do not overwater or flood the soil.
- Sow 12 equal sized seeds in each pot.
- Place the three pots at three different locations to expose them to different light intensities.



Notes

- (a) Place them such that one pot is kept in bright sunlight.
- (b) One in deep shade under or thick bush.
- (c) And the third one inside a cupboard.
- Leave the pots for ten days and during this period keep the soil moist by watering the pots regularly (do not overwater).
- On the 10th day remove all the pots and take them to the laboratory for noting the observations.

OBSERVATIONS

Make the following observations on the 10th day using your experimental data and record in a tabular form as given below.

- (i) Number of seeds germinated in each pot: _____
- (ii) Colour of seedling and leaves (if any): _____
- (iii) Height of seedlings: _____
- (iv) Length of internodes: _____
- (v) Number of leaves produced per plant (seedlings): _____

- Select any three healthy seedlings for observing height of seedlings, length of internodes and number of leaves produced per plant.
- The second internode from the base of each seedling should be considered for measuring the internode length.
- The average value should be taken as the final result and compared to study the effects of three different light intensities on the growth of seedlings.

Observation table for comparing plant growth at different light intensities:

No.	Points to be observed	Bright Sunlight	In shade (under as bush)	In dark (Inside cup board)
1.	Number of seeds germinated			
2.	Colour of seedling			



Notes

3.	Height of seedling	i) _____ ii) _____ iii) _____	Mean _____	i) _____ ii) _____ iii) _____	Mean _____	i) _____ ii) _____ iii) _____	Mean _____
4.	Length of internodes	i) _____ ii) _____ iii) _____	Mean _____	i) _____ ii) _____ iii) _____	Mean _____	i) _____ ii) _____ iii) _____	Mean _____
5.	Number of leaves per seedling	i) _____ ii) _____ iii) _____	Mean _____	i) _____ ii) _____ iii) _____	Mean _____	i) _____ ii) _____ iii) _____	Mean _____

RESULT

From the observation table present the result in a summarized manner.

DISCUSSION

- Light is an important environmental factor, which plays a very significant role in the growth of plants in various ways. Plants grown in the dark look very different from plants grown in bright light. Light affects the process of elongation of cells of the internodes. Light is important for the development of the green pigment, chlorophyll in plants.
- On a single plant or a tree, leaves may differ in appearance and activity depending on whether they are on the outside of the leaf canopy (sun leaves) or within the interior of the canopy (shade leaves).
- Leaves of the plants grown in sunlight are generally thicker and smaller in size as compared to the leaves of the plants grown in shade or in dark are thinner and larger. Ecologically it is of great significance that seeds of trees do not grow under its own shade. This is a natural protection against competition for water, nutrients and light for the growing seedlings.

PRECAUTIONS

1. The pots used should be of uniform size and same soil should be used in all three pots.
2. Make sure that pots are kept at different sites receiving different intensity of light.

FOR THE TEACHER

- To help the learner to carry out the experiment and record observation.



Notes

EXERCISE - 12

AIM : TO SET UP AN AQUARIUM

Aquarium represents a miniature, man made ecosystem and is maintained in a water filled container with the aide of certain materials, aquatic plants, animals and fish.

To watch a well lit aquarium that is beautifully decorated with plants, rocks and colourful fish swimming around is fascinating. Attractively stocked and planted aquaria are common sight in waiting rooms, resting places and hospitals. Watching these beautiful organisms is indeed a very pleasurable experience.

OBJECTIVES

After performing this exercise, you will be able to:

- set up an aquarium and learn the steps to do so in the correct sequence;
- observe the movements of fish in an aquarium;
- to appreciate the importance of an aquarium as a means to learn certain biological principles such as interdependence of plants and animals, role of bacteria in nitrogen and other material cycles in nature.

WHAT YOU SHOULD KNOW

1. Keeping fish is fun. But there are a few basic things you need to know before setting up the aquarium.
2. Aquarium is a water filled glass/ plastic tank to keep live fish and aquatic plants. It requires a base or substratum of gravel for plants to anchor and fish to burrow and lay eggs. The floor bed also acts as a source of minerals and as a biological filter. Water passes through the gravel and bacterial colonies develop there. They convert the waste into ammonia and nitrites and then into nitrates. Nitrates are taken up by plants (try to recall the nitrogen cycle you have already studied).
3. Live plants form a natural ecosystem. Plants produce oxygen during photosynthesis in the day time and also help to keep the water clean by absorbing



Notes

nutrients produced from fish waste (by decomposing bacteria). Fish take the oxygen from water for respiration.

4. Fish food is added from outside as per requirement. Fish also require a comfortable temperature to survive. Water filter, aerators, water heaters and electric lamp help maintaining suitable conditions in the aquarium for plants and animals to thrive and grow. Once learnt, setting up an aquarium becomes interesting and rewarding.

MATERIAL REQUIRED

- (i) A glass or plastic container of approximately 20-30L capacity; aquarium cover with bulb or florescent light fitting (2-3 Watts per Gallon/4.4 L of water) ;
 - Gravel (river/sea sand 2-3mm grain size; 10-15 kg. Only thoroughly cleaned gravel should be used for the tank floor; decorative pieces of rocks-3/4 pieces)
- (ii) Accessories like air pump, filter, water heater with thermostat (required only in areas where the temperature dips below 15 degrees Celsius);
- (iii) Fish net
- (iv) Live materials - Aquarium plants such as *Hydrilla*, *Vallisaria*, *Elodia*, Indian fern;
- (v) Small fish for the aquarium such as Gourami, Guppies, Neon tetras, Angel fish, Black molly, Goldfish, Swordtail, Zebradanio etc.
- (vi) Fish food - fresh or readymade granules

METHOD

- Arrange or buy a suitable tank of 20-30-L capacity. The recommended size is around 42cm x 22cm x 35cm tank. Too small a tank is not recommended for the beginners. The glass tank with metal frame and on a metal stand is stable and lasts longer. Ensure that the tank is leveled.
- Wash the aquarium inside and out with tap water. Do not use detergents or glass cleaners. Check for any leaks.
- Select the place where you want to keep the aquarium. It is best located near the window but away from direct sunlight as it leads to excessive algae growth. The side towards the window may be covered with paper if required. The place should also be near an electric outlet.



Notes

- Next, collect river or sea sand or gravel for constructing the aquarium base. Wash it thoroughly by putting it under running tap water. Keep stirring the sand/gravel until the water that flows out from it becomes clean. Idea is to get it as clean as possible. Now spread it in sun, preferably on a sheet of paper to dry. This will eliminate the microbes present in the sand. Use this washed and dried sand for the aquarium.
- **Adding gravel:** Use thoroughly washed aquarium gravel to cover the floor of the tank and the filter plates (if used). Put about 4 inches of the gravel and give it a slope so that it is slightly lower towards the front. This allows the sediments and waste particles to drift down to where they can be easily siphoned off during cleaning. Gravel bed is home for friendly bacteria to grow and make biological filtration possible. They breakdown the animal and plant wastes to simple inorganic matter for plants to absorb.
- Lighting is important and aquarium with a bulb/ fluorescent tube in the cover/ hood not only illuminates the fish but also encouraged healthy plant growth.
- Next, you have to decide on the decorations. They enhance the look of the aquarium. You may install decorative rocks and driftwoods. Use thoroughly washed rocks and other materials only. Arrange them as desired taking care that it does not obstruct the free movement of fish. Rocks make a good background for fish.
- Installation of water heater. The temperature of the water should be maintained around 22–25° Celcius. A water heater is required for places where the temperature dips to a very low level. These days a combined heater and thermostat enclosed in a water tight glass tube is used and is kept in place by special clips. Install these equipments as per package directions. Later the equipment is hidden behind the aquarium plants. All electrical connections should be outside the aquarium.



Vallisnaria



Hydrilla

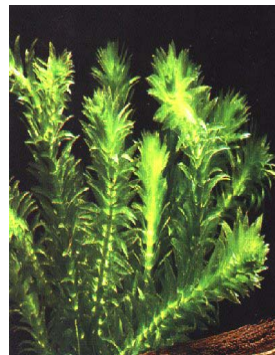

Elodea

Fig.: 12.1 Aquarium Plants



Notes



Fig. : 12.2 Aquarium

- Your tank is now ready to be filled. Fill two thirds of the aquarium with tap water. Run the water gently on a plate or a flat rock kept in the aquarium base. This way the gravel will not be disturbed. Let the water stand for a day or two so that the chemicals like chlorine and ammonia, harmful to the fish get evaporated.
- You can now add the plants in the tank. Roots should be gently pushed down into the gravel. Arrange the plants behind the rocks and at the side of the tanks so as to make an attractive background. Put the tall plants at the back and small rosette type plants at the foreground.
- Let the plants and the new 'ecosystem' settle for atleast three days before adding fish to it.
- Aquarium is now ready for adding the fish. Procure fish from a local source or purchase from the local pet shops available in big cities. There are some good beginners fish like Zebrafish, molly and guppy. You are advised to start with slender fish only. The safe amount of fish is considered to be 1 inch of fish per gallon of water (4.4L). This calculation is suitable to slender fish like zebra (see the diagram). The calculation differs for other types of fish. The details are available in the books/web sites. As you learn more about the aquarium you can go on adding other fishes. Predatory fishes should be avoided.
- After procuring the fish it is necessary to hang the pouch/bag containing the fish into the tank/aquarium for 15-20 min to acclimatize the fish to the tank temperature only then they should be released into the tank water.

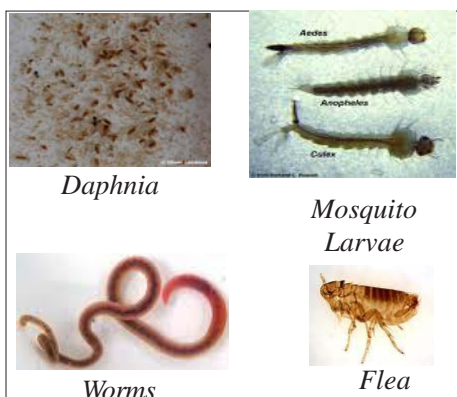

Fig.: 12.3 Pictures of live fish food



Fig.: 12.4 Pictures of common aquarium fishes

- Adding fish food. In addition to balanced fish food sold in the market, live food in the form of water borne insects (Daphnia, flea), worms , mosquito larvae are also given as fish food. Vegetarian fish eat algae. Too much food should always be avoided as it will decompose and pollute the aquarium.
- Provided you have not overcrowded the fish (1 inch of fish to a gallon of water) you will not require things like filter or aeration pump, as enough oxygen will be produced by the plants and surface of the water. Filters are an important component of an aquarium as they remove wastes produced by fish. Filters are available in three forms: the under gravel filters, box filters and outside filters. If you require, read the instructions on the pack age and then take your decision. Same is applicable for the aeration system.

Cleaning the aquarium: you need to keep it clean by:

- changing the water every week or two to remove the chemicals that have built up. Never empty the aquarium completely. Change 10 -25% of the water at a time.
- using a scrubber with a long handle/brush to clean the walls of the tank. Too much of direct sunlight leads to green algae forming on the glass of the tank.
- Your aquarium is now all set. Take care of your little pets and you will have many enjoyable days and nights watching the fish swimming about the aquarium. Observe their feeding and swimming patterns.

OBSERVATIONS

- Find out which ones like to hide every now and then, which ones are fast or slow swimmers. Also observe their direction of movements. Observe their growth pattern for next 10 day. Record your observation in the table provided.



Notes

OBSERVATION TABLE

Movements					Size		
Name of the fish	Time taken by the fish to feel comfortable after its release in the tank	Time taken by the fish to complete one turn	Does it like to hide behind objects frequently Yes/No	Does it prefer to move vertically, horizontally or randomly	Initial size when introduce	Size after 4 days	Size after 10 days

PRECAUTIONS

1. Avoid too big an aquarium to begin with.
2. Select the place carefully and do not try to move the aquarium after filling it.
3. Avoid placing it in direct sunlight.
4. Use uncontaminated source of water, plants and animals.
5. Maintain cleanliness and right temperature.

CHECK YOUR UNDERSTANDING

1. What is the role of the substratum in an aquarium?

2. Where do healthy bacteria thrive in an aquarium?

3. List the plants and animals that can be introduced in aquarium.

4. What is the desirable temperature in the aquarium?

5. Mention the ideal location of an aquarium.

6. List the electrical equipments used to maintain suitable conditions in the aquarium.

7. Why should the aquarium not be kept in direct sunlight?

8. How are plants useful to the fish?

9. How are fishes useful to the plants?

10. Can an aquarium be left as such after setting up?



Notes

FOR THE TEACHER

- The teacher may help the learner in selecting the plants and fish suitable for the aquarium and in maintenance of the aquarium.



Notes

EXERCISE - 13

AIM : TO STUDY THE BIODIVERSITY OF BIRDS AND INSECTS IN YOUR LOCALITY.

Biodiversity is the variety of living things in an environment. Study of biodiversity has a great appeal, for we believe in the kinship of all living organisms. Modern Science has reaffirmed this kinship with the latest evidence that we still carry as a part of our own hereditary constitution a considerable number of the genes of the smaller organisms like yeast. It turns out that the diversity of life peaks in small insects such as the weevils that infest stored cereal grains.

Living organisms interact with each other in many different ways. They may help each other. They may prey on each other. They may compete with each other. They may behave as hosts or parasites.

Organisms are distributed in various habitats and are dependent on various habitat components for their survival. Due to increased human activities, natural habitats get altered and modified. This could affect organisms in different ways.

All the above facts support the significance of the study of biodiversity. The world of insects and birds is fascinating! So, the study of the biodiversity of birds and insects is a harmonious blend of fun and study.

OBJECTIVES

After performing this exercise, you will be able to:

- enlist a large number of insects and birds;
- appreciate the biodiversity;
- realize the significance of the biodiversity;
- understand the relationship of the insects and the birds with their environment;
- understand their habit and habitat.

WHAT YOU SHOULD KNOW

1. Insects belong to the most diverse class of the animal kingdom.
2. Insects are invertebrates whereas the birds are vertebrates.
3. Though both the insects and the birds have some common functional features such as they are both adapted to fly, but they greatly differ from each other in their fundamental anatomical features.
4. Every organism has some adaptive features which help it to survive better in a particular environment.



Notes

MATERIAL REQUIRED

(i) Binoculars	(v) Nylon mosquito net
(ii) Aluminium Cloth hanger	(vi) Record book
(iii) Glue	(vii) Pen
(iv) Sweep net	

METHOD

- Where to look for insects is the first task. Most insects live above the ground. Many live on grass or on larger shrubs and trees, some under rocks or decaying pieces of wood. Also, large variety of insects lives inside the carpet of dead leaves (leaf litter) that cover the ground under all vegetation.



Fig.: 13.1 Sweep Net



Notes

- You may require a sweep net to catch insects. This you can make yourself easily. Bend an aluminum cloth hanger into a round loop. Straighten out the hook to make a short handle. Take a 25 cm wide piece of nylon mosquito net cloth. Stitch its two ends to get a 25 cm, long tube. Attach its one end into the one loop and close the other end by stitching. You may also attach a wooden handle to the short handle of the loop. Now your sweep net is ready.
- Using the sweep net catch some insects; Observe each and record your observations.
- For observing a bird you have to be a keen observer. You do not need to catch the bird. Simply watch it. You may require a pair of binoculars. If possible take a photograph of the bird. Then record your observations.
- Record your observations for each insect or bird datewise on separate sheets. Paste photograph of the insect/bird appropriately or else draw its diagram.

PRECAUTIONS

1. Always wear surgical gloves while looking for insects in grass, under rocks or decaying pieces of wood.
2. Due care should be taken while studying insects or birds and there should be no harm caused to any life.
3. Take care of personal safety like avoiding stings and bites.
4. Avoid contact with poisonous plants etc.
5. General care should also be observed while observing while collecting samples from any swampy area as well as from steep slopes.

OBSERVATIONS

Prepare separate observation – sheet for each day for each insect or bird:-

(i) Record the following observations for insects –

- 1) Date of observation: _____
- 2) Place where the insect was found: _____
- 3) Common name of the insect: _____
- 4) Draw a sketch of the insect. / Take a photograph: _____
- 5) What is the food of the insect: _____
- 6) Main features of the body of the insect: _____
- 7) Any other interesting observation that you might have made about the insect:

*Notes***(ii) Record the following observations for birds –**

- 1) Date of observation: _____
- 2) Place where the bird was found: _____
- 3) Common name of the bird: _____
- 4) The kind of food the bird eats: _____
- 5) Colour of the bird: _____
- 6) Size of the bird: _____
- 7) Shape of the bird: _____
- 8) Shape of the beak of the bird: _____
- 9) Any other interesting fact: _____

DISCUSSION

- Which bird and insect were seen in the same period of the year?

- Did you see any migratory bird? If yes, describe.

- Did you see any insect which formed food for birds seen during that period of year?

- Did you see any insect useful for pollination in plants? If yes, how?

- Were you able to figure out some birds which contribute to plants for pollination or dispersal of seeds?

- What is the contribution of insects and birds as constituent's biodiversity?

FOR THE TEACHER

- Help learner in identifying common insects and birds.
- Help them distinguishing between mouth parts of insects or beaks of birds and relate them to kind of food ingested.



Notes

EXERCISE - 14

AIM : TO PREPARE A LIST OF PLANTS AND ANIMALS WHICH ARE USED FOR MAKING MEALS AT HOME ON ANY ONE DAY AND TO COMMENT ON THE HABIT AND HABITAT OF EACH.

Humans are dependent on plants and animals for food. Though not all plants and animals are edible, there is still a wide variety which serves as food for humans. Similarly not all parts of the same plant may be used to prepare a delicious dish. This exercise deals with identification of habit and habitat of edible plants and animals.

OBJECTIVES

After performing this exercise, you will be able to: -

- learn about the edible parts or products of plants and animals;
- comment on the habit and habitat of these plants and animals.

WHAT YOU SHOULD KNOW

1. Names of parts of plants; modified roots and stems.
2. Skeletal and fiscal tissues of edible animals; edible animal products.

MATERIAL REQUIRED

- | |
|---|
| <ol style="list-style-type: none">(i) Record book(ii) Pen / pencil |
|---|



Notes

METHOD

- Prepare the list of items of food consumed by you at breakfast, lunch and dinner the previous day and also list the ingredients obtained from plants and animals which have been used for making them.
- Make sure that your list is complete and exhaustive.
- Include spices, pulses, grains used in cooking the food item.
- In case you are vegetarian, find out about non-vegetarian food form others and include in your list.

OBSERVATIONS

Tabulate your information about each item as given below. Make separate tables for plants and animal products.

Food item	Edible part of plant or animal	Name of the plant or animal	Habit of the plant/animal	Habitat of plant/animal
1				
2				
3				

For tabulation, the following points are suggested:

Plants –

Parts of plants – Root/leaf/stem/bud/flower/fruit/seed/grain.

Habit edible of the plant – Herb/shrub/fruit/seed/grain.

Habitat of the plant – Aquatic (fresh water, marine, pond, river etc) or terrestrial

Animals –

Parts/Product eaten – milk /egg/muscles.

Habit of the animal –Omnivorous/ herbivore/carnivore/insectivore/bones/frugivore.

Habitat of the animal – Aquatic/terrestrial/aerial.

DISCUSSION

- Discuss in your own words, the dependence of humans of plants and animals for food.



Notes

PRECAUTIONS

1. Let your list be exhaustive and not sketchy so that you can learn about the variety of habits and habitats of plants and animals.
2. Never feel shy to ask others about their food habits. It will not only increase your knowledge but have your communication skills.

FOR THE TEACHER

- Make sure learners gather enough information regarding edible plants and animals and become aware of the variety of plants and animals that are eaten as food.



Notes

EXERCISE - 15

AIM : TO MAKE A HERBARIUM SHEET

Books are kept in the libraries in a classified manner, so that it becomes easier to find a specific book when needed. The same idea applies to systems cataloging different plants.

Plants are dried and mounted on hard sheets of paper in a classified manner in a herbarium. Processing of a plant for mounting on herbarium is an important technique.

OBJECTIVES

After performing this exercise, you will be able to:

- develop skill for collecting plants for their study;
- process plants for mounting on herbarium sheets;
- learn the technique of classifying plants.

MATERIAL REQUIRED

- | | |
|------------------------|-------------------------------------|
| (i) A gardener's knife | (vii) Water |
| (ii) A plant press | (viii) Cover slips |
| (iii) Trowel | (ix) Tags |
| (iv) Herbarium sheets | (x) Label |
| (v) Tape | (xi) Blotting papers or news papers |
| (vi) Pen | |



Notes

WHAT YOU SHOULD KNOW

1. A herbarium is a collection of dried plants that have been pressed and mounted on paper sheets.
2. Dried plants are classified and arranged for future reference and taxonomic studies.

METHOD

1. Collect 10 to 15 plants of different types from various localities with the help of knife and trowel.
2. The plants should be from at least five different groups.
3. The plants should be moistened with water and kept in the plastic bags during collection.
4. At the time of collection, the plant specimen should have all the parts such as flower, fruit, leaf, stem and root.
5. Write name of the location, from where the specimen has been collected. This should be tagged with the plant.
6. To dry the collected plant use blotting papers with plants on it which may be stacked in a pile. Plants should be spread evenly between the sheets of blotting paper or newspapers.
7. Then the plant should be pressed with the help of a plant press. If the plant press is not available, then some other heavy object having plane surface can be used for the purpose.
8. While pressing, care must be taken that leaves of the plants are spread well. They should not overlap. Pressure should be applied uniformly on the entire plant.
9. The plant should be pressed under some heavy weight for about three days.
10. After three days weight is removed and the dried specimens are mounted on the herbarium sheets/big drawing sheets with the help of tape.
11. Only one specimen should be mounted on one herbarium sheet.
12. On each sheet the following detail should be given on the lower right hand corner.

(i) The site of collection: _____

(ii) Date of collection: _____

(iii) Name of the plant: _____

(iv) Family: _____

(v) Ecological and morphological note: _____

(vi) Habitat: _____

(vii) Name of the collector: _____

13. Herbarium sheets should be preserved safely with moth balls/naphthalene balls etc.



Notes

OBSERVATIONS

These sheets should be presented in the form of a file.

(i) The site of collection _____

(ii) Date of collection _____

(iii) Name of the plant _____

(iv) Family _____

(v) Ecological and morphological note _____

(vi) Habitat _____

(vii) Name of the collector _____

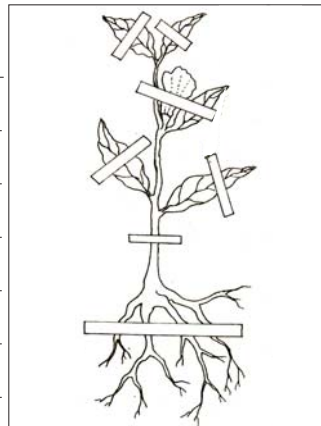

PRECAUTIONS

1. If a plant is too large than a 12 inch long flowering twig can be collected.
2. The leaves must be pressed in a manner that they do not overlap and get crinkled.
3. Make sure that the plants contain flowers.

FOR THE TEACHER

- Learners should be helped in preparing the herbarium and identifying plants.
- Significance of taxonomic classification may be explained by the teacher.



Notes

EXERCISE - 16

**AIM : TO DESCRIBE : A) CLIMATE OF AN URBAN AREA;
B) YEARLY VARIATION IN SUSPENDED PARTICULATE
MATTER IN THE SAME AREA.**

Weather is the state of the atmosphere at a particular place and time in terms of temperature, wind, rain, humidity etc. Climate of an area is an average pattern of weather conditions over of long period of time. The lives of all organisms are affected greatly by the changes to the weather conditions. Every organism requires optimal conditions of weather for its survival.

Pollution is the undesirable changes in the environment which makes it less suitable for the survival of the organisms. The change may be physical, chemical or biological. The agents that cause pollution are called pollutants.

Since weather conditions and pollution levels have direct impact on the lives of organisms, it is of great significance that we study the weather patterns and the air pollution levels and make the weather chart and pollution level chart. The two can be joined together to have a wholesome view. That pollution is influencing the climate on planet earth is obvious from global warming. Therefore, making a climate chart of an urban area alongwith yearly variation in suspended particulate matter is important.

Air pollution is a growing problem. Air pollutant may be gaseous or particulate. The particulate matter suspended in air with size less than 10 μgm is called Respirable Suspended Particulate Matter (RSPM). The RSPM causes several respiratory system disorders.

OBJECTIVES

After performing this exercise, you will be able to:

- enlist factors affecting climate;
- enlist components of weather;
- understand patterns of changes each component undergoes over the months in a year; interpret the weather chart;

- present the data in the form of bar graph;
- realize the significance of pollution control.



Notes

MATERIAL REQUIRED

(i) Thermometer	(iv) Local daily newspaper
(ii) Rain gauge	(v) TV news
(iii) Hygrometer	(vi) Internet

WHAT YOU SHOULD KNOW

1. Climate of an area is an average pattern of weather conditions over a long period of time.
2. Weather is the state of the atmosphere having taken into account all its components such as temperature, wind, rain, humidity etc.
3. Weather of a place may be different from that of some other place at the same point of time.
4. Weather of a place may also vary with the passage of time.
5. Study of climate cannot be done without the data of weather components.
6. Pollution is largely a consequence of human activities.
7. The biggest cause of the pollution is one the combustion of fossil fuels.

METHOD

1. For making a climate chart showing monthly values of climate variables and RSPM values. You need a maximum-minimum thermometer, rain-gauge, hygrometer etc. Else you can collect data from local daily newspaper, Central or State Pollution Control Board, television or internet on daily basis.
2. You have to make the entries as per the following table for each month of a year.

MONTH : _____

Date	Maximum Temp. (0°C)	Minimum Temp. (0°C)	Rainfall	Humidity (%)	Relative Humidity	RSPM* (ppm)
Total						
Average						

* RSPM stands for Respirable Suspended Particulate Matter.



Notes

OBSERVATIONS

- (i) Calculate average value of each component for each month.

- (ii) Taking month on x-axis and a component (say Maximum temperature) on y-axis make bar charts for each component.

- (iii) Analyze your observations.

DISCUSSION

- Which month of the year shows the highest average maximum temperature and why?

- Which month of the year shows the lowest average minimum temperature and why?

- Which month of the year shows the highest average rainfall and why?

- Which month of the year shows the lowest average rainfall and why?

- Which month of the year shows the highest average humidity and why?

- Which month of the year shows the lowest average humidity and why?

- Which month of the year shows the highest average relative humidity and why?

- Which month of year shows the lowest average relative humidity and why?

- Which month of the year shows the highest average RSPM?

- Suggest some measures to control the amount of RSPM in air?
-



Notes

CONCLUSIONS

- Draw conclusions based on answers to above mentioned questions.

PRECAUTIONS

1. Collect the data carefully and accurately for arriving at correct results and conclusions.

FOR THE TEACHER

- Guide the learner regarding sources available for collecting relevant data.

*Notes*

EXERCISE - 17

AIM: TO MAKE AN AUDIT OF THE ELECTRICAL ENERGY CONSUMPTION BY VARIOUS HOUSEHOLD APPLIANCES.

All living organisms rely on external sources of energy. In case of green plants, it is radiation from the sun; in case of animals – it is chemical energy. All this energy is required for the organisms to be able to grow, to reproduce and to work. In addition to this, humans also consume energy in many other ways such as electric bulbs, cars, fans, air conditioner, television, cooking ovens, chullahs, machines etc.

Almost everything that makes our everyday life computable requires energy. So, it would be very significant to study the pattern of energy consumption at our home. To simplify, the study can be delimited to the electrical energy. To make an audit of electricity consumption means to quantify the electrical energy use and prepare its account to understand the pattern of electricity consumption at home or any other establishment.

OBJECTIVES

After performing this exercise, you will be able to:

- enlist the sources of energy at your home;
- calculate how much electrical energy your home consumes;
- know whether your home follows any energy conservation practice;
- find out the ways to minimize energy consumption at home.

MATERIAL REQUIRED

- | | |
|-------------|------------------|
| (i) Pen | (iii) Notebook |
| (ii) Pencil | (iv) Graph paper |



Notes

WHAT YOU SHOULD KNOW

1. Domestic electric supply in India is at 220 V.
2. Commercial unit of electrical energy is Kilowatthour. (1 Kwh = 1 Unit)
3. All electrical appliances bear on them the power in watt. (i.e. rate at which they consume energy)
4. Make a list of electrical energy consuming items (appliances) used at your home with their power rating in watts. The electrical appliances may be:
 - (i) Lighting appliances such as bulb, tube, CFL etc.
 - (ii) Heating appliances such as geyser, kitchen equipments like microwave oven, heater etc.
 - (iii) Refrigerator
 - (iv) Fan and exhaust fan
 - (v) Air conditioner
 - (vi) Water pump
 - (vii) Office equipments such as computer, printer, fax etc.
 - (viii) Miscellaneous items such as inverter, television etc.
5. Energy consumed can be calculated by using the formula –

<p>Energy = Power × Time</p>

METHOD

Electrical Energy audit at home can be done in the following steps–

- Note the duration in hours for which an appliance is used at home on daily basis. Remember if three electric bulbs are used, the duration of their use must be noted separately and collectively as it is not necessary that all the bulbs are used for the same duration.
- The above data should be filled in the following observation table. (NOTE – The Column (b) of the table can be modified according to the number and types of electrical appliances used at your home).

OBSERVATIONS

- (i) Present your result in the form of a pie chart for the electricity energy consumption during a day by various electrical appliances at your home.



Notes

S.No.	Electrical appliance	Power of Electrical Appliance (in Watt)	Duration of which used (in hours)	Energy consume (in watthour) i.e. product of (c) and (d)
(a)	(b)	(c)	(d)	(f)
1.	Bulb No. 1	---	---	---
2.	Bulb No.2	---	---	---
3.	Bulb No.3	---	---	---
4.	Tube Light	---	---	---
5.	Fan	---	---	---
---	---	---	---	---
---	---	---	Total	---

Making a Pie chart

Suppose electrical energy consumption by various appliances on any one day in a household is as given below.

S.No	Electrical Appliance	Electrical Energy consumption (Units)
1	Electrical bulb	0.36
2	Fan	1.26
3	Refrigerator	2.00
4	Cooler	1.80
5	Television	0.90
	Total	<u>6.32</u>

For the electrical consumption by each appliance, corresponding angle of pie chart can be obtained using the formula

$$\theta = \frac{\text{Electrical Energy Consumption by the appliance}}{\text{Total Energy consumption by all appliance}} \times 360^\circ$$



Notes

Thus, the following table is obtained for making a pie chart-

S.No	Electrical Appliance	Electrical Energy consumption
1	Electrical bulb	20.5°
2	Fan	71.8°
3	Refrigerator	113.9°
4	Cooler	102.5°
5	Television	51.3°
	Total	360°

Now draw a circle and a radius in it. Make corresponding angles for each appliance at the centre of the circle.

- (ii) Similar tables are filled in date wise for a month.
- (iii) Total electrical energy consumed during a month is calculated adding the totals of column (e) of all the tables of different dates of a month.
- (iv) Modified according to the number and types of electrical appliances used at your home
- (v) Total electrical energy consumed during a month obtained in step 3 is in watt-hour. Therefore it is divided by 1000 to convert it into kilowatt-hour .

1 kilowatt-hour = 1Unit.

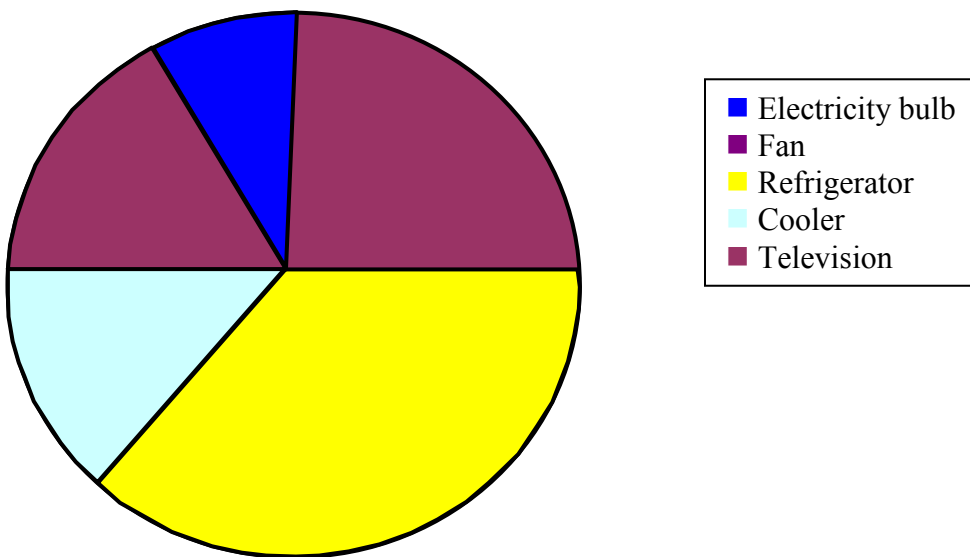

Fig. 17.1: Electrical Energy Consumption by Household Appliances Through Pie Chart



Notes

RESULT

Total electrical energy consumed in the month = _____ kilowatt-hour.

DISCUSSION

On the basis of observations and result analyse the following aspects –

- Which device (s) / appliance (s) consumes more electrical energy?

- Where do you find any wastage of energy that could be avoided?

- Is there any alternative appliance for any existing one that can reduce consumption of electrical energy? (e.g. CFL in place of bulb)

- What other measures could be taken to save energy.

- How is the energy economy level displayed on certain appliances?

PRECAUTIONS

1. Each and every electrical appliance used at home should be included in the list for the audit.
2. The duration of use varies from one appliance to other. Therefore, the duration for which an appliance is used should be recorded carefully.
3. Power rating of the appliances should be recorded in watts whereas duration of use in hours.
4. Certain appliances are used in particular period of the year depending upon the weather conditions such as geyser, cooler etc. Therefore, energy audit for a month should never be used to calculate average energy consumption for the whole year.

FOR THE TEACHER

- The teacher may help the learner in identification of electrical appliances with lower voltages / higher efficiency.
- The teacher may also help the learner in identifying the energy economy level printed and pasted on the electrical appliances.

CURRICULUM

ENVIRONMENTAL SCIENCE PRACTICAL MANUAL

The purpose of teaching Environmental Science is not only to acquaint the learner with theoretical knowledge but also to develop practical skills. Development of these skills leads to better understanding of the environment through hands-on experience and mutual reinforcement of theory and practice. Field exercises and laboratory work develop psychomotor skills. The present course involves field work, laboratory exercises and short innovative projects to exercise creative thinking and problem solving skills. The list of practical exercises to be carried by a student as part of this course on Environmental Science is given below:

A. FIELD STUDIES (ANY THREE)

1. Study a simple ecosystem (suggested habitats-pond, river, estuarine, lake, grassland, forest, and desert) and describe the biotic and abiotic components of the ecosystem.
2. Study of the effect of human interactions with the natural environment.
3. Survey of vegetation, birds, insects and other animals in your locality.
4. Choose five common tree species plants from your neighbourhood and list their common names. Describe each plant in terms of its height and leaf characteristics.
5. Describe the environmental problem of your locality and suggest their remedy.
6. Visit to different water bodies in your village/ locality and describe their uses and source of water pollution. If any

7. To segregate domestic solid waste into biodegradable and non-biodegradable components.

B. LABORATORY EXERCISES (ALL)

1. Study of water quality.
2. Soil texture and analysis of components.
3. To estimate dust (particulate) deposition on the leaves of road side plants.
4. To study the effect of light intensity on the growth of plants.

C. CREATIVE ACTIVITIES (ANY TWO)

1. Set up an aquarium.
2. To study the biodiversity birds and insects in your locality.
3. To prepare a list of plants and animals which are used as food for humans and to comment on their habit and habitat.
4. Make herbarium sheets of 10 different plants/trees. Consult your teacher how to make a herbarium sheet.
5. To describe: a) climate of an urban areas; b) yearly variation in suspended particulate matter in the same area.
6. To make an audit of the electrical energy consumption by various house hold appliances of your home.

PRACTICAL EXAMINATION

There will be a practical examination of 3 hours duration and maximum mark 20. The distribution of marks is as follows:

1. Field Studies	:	05 marks
2. Laboratory exercises	:	03+02 marks
3. Creative activity	:	05 marks
4. Practical record and Viva-voce	:	03+02 marks
		<hr/>
Total		20 marks